

Corner & connection

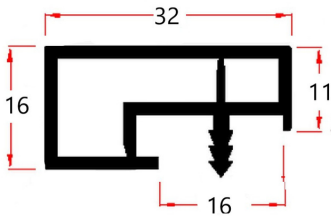

PVC3216/16 TC

Suitable for 16 mm chipboard also available for 19 mm chipboard

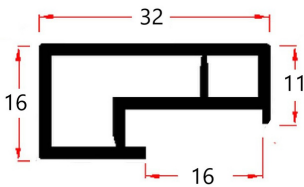

PVC3216/16 C

Finishes:
Plain colors
Decorative film
Lacquer

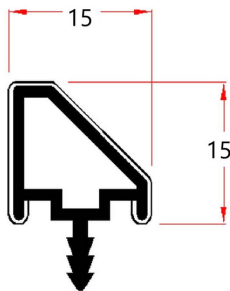

PRONEZ 1616T
for 15 mm chipboard

Finishes:
Plain colors
Decorative film
Lacquer

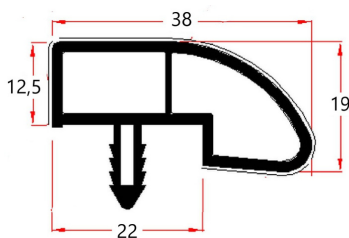
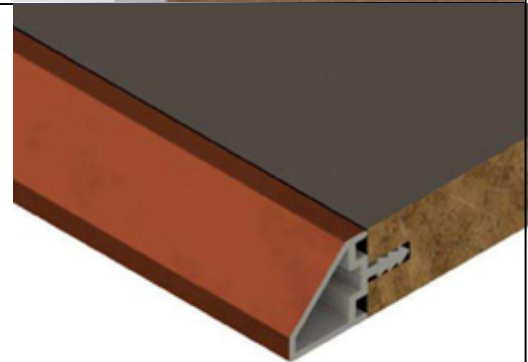

PRONEZ 3819UT
for 22 mm chipboard



Corner & connection



Finishes:
 Aluminum covered
 Plain colors
 Decorative foil
 Lacquer

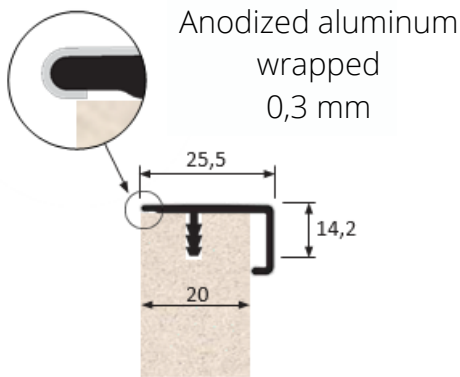

JOI 1426T

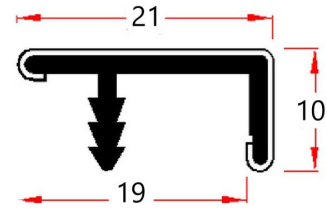

JOI 1019T

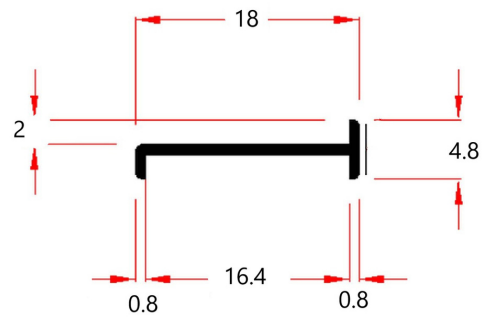

PCA 5164 PL

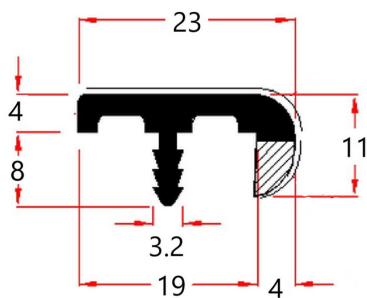

PRONEZ 1119 T BICOL

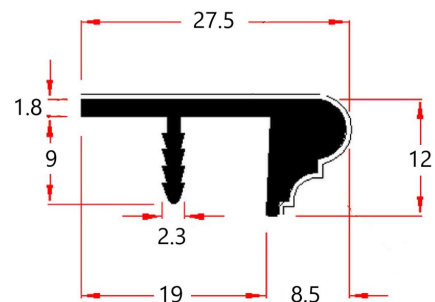

LP 1219 T

Corner & connection

PRONEZ 18517T
Suitable for 16 mm board

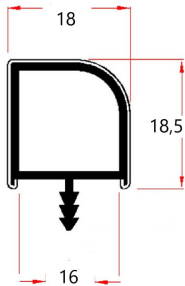

Finishes:
Plain colors
Decorative film
Lacquer

PRONEZ 21520T BICOL
For 20mm board
Co-extruded in two colors

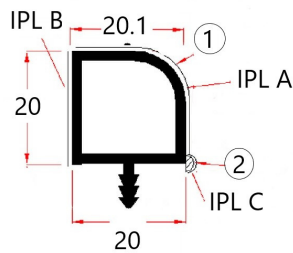

EMB PRONEZ21520T BICOL
ANGAR PRONEZ21520T BICOL
ANGAR POI PRONEZ21520T BICOL



PVC 5225 TR
for 25 mm board

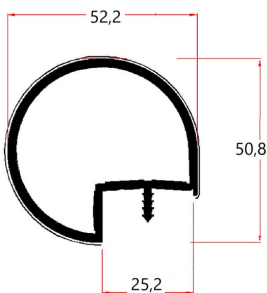

Finishes:
Plain color
Decorative foil
Lacquer

PVC 3216 TR
(16 mm panel)
PVC 3219 TR
(19 mm panel)

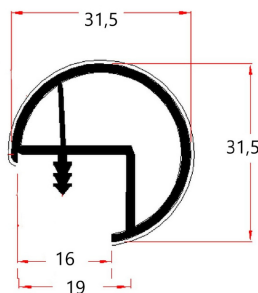

EMB PVC 3216 TR



PIED M8 PVC 5225/75 CIRC
Height adjustable

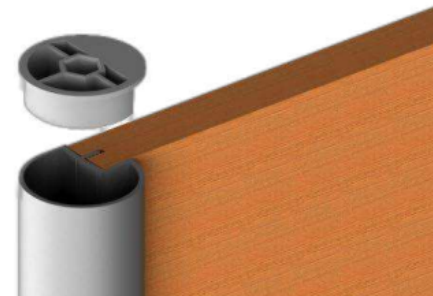

Corner & connection

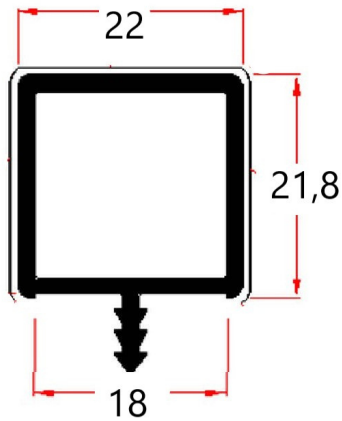

PVC 2222 TC
Suitable for 18 mm
chipboard

Finishes:
Plain colors
Decorative foil
Lacquer

Different decoration
possible on all visible
sides

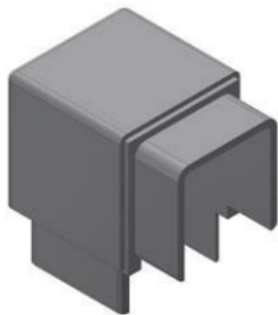
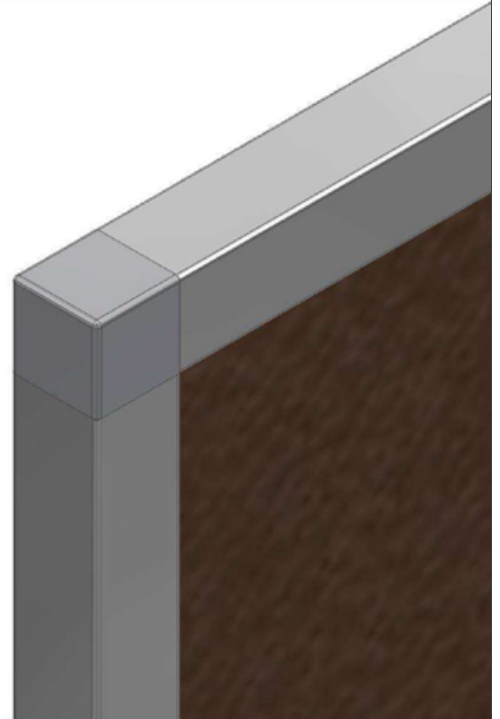

ANGAR PVC 2222 TC

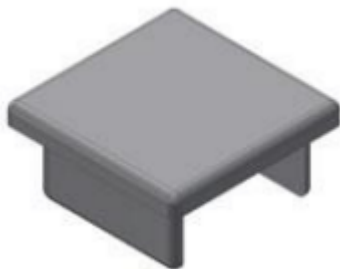

EMB PVC 2222 TC

